

Wanna Progres 180x80 - rozmieszczenie elementów w systemach W400, MX600, MX600PRO

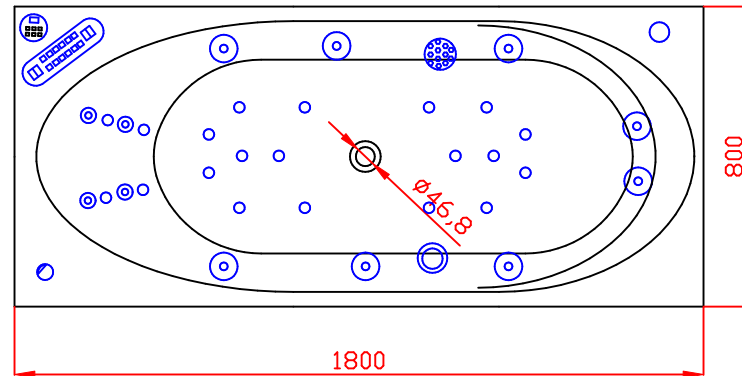
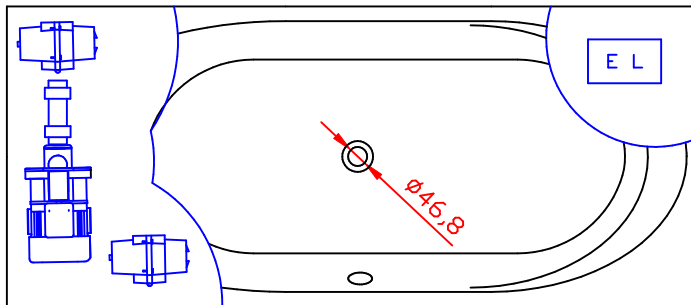
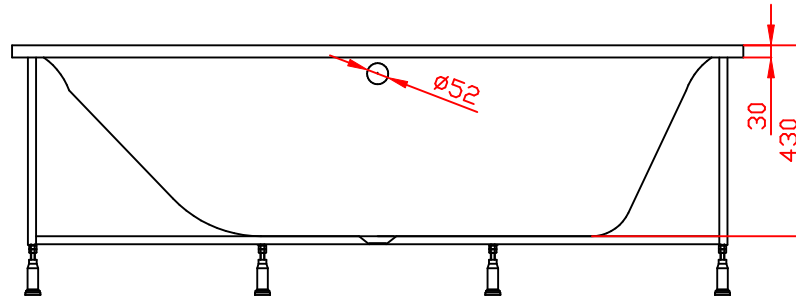
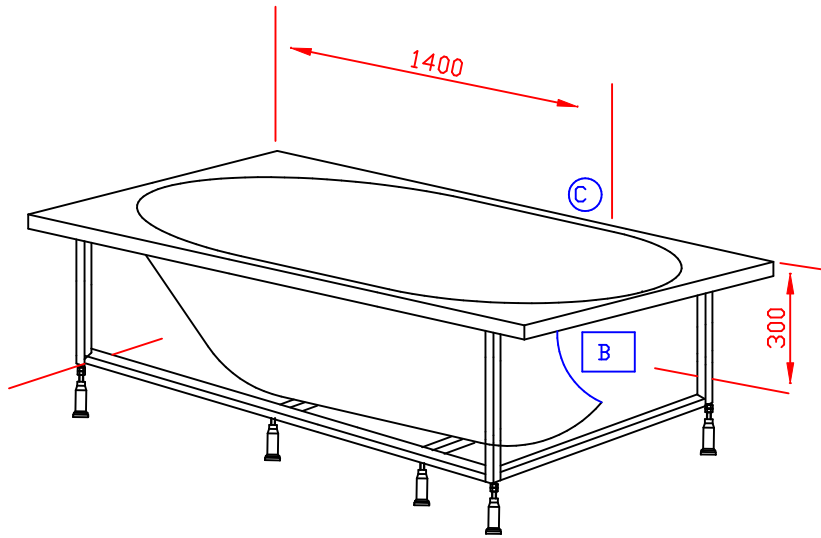

(B) Rekomendowane położenie instalacyjnej puszkii elektrycznej o stopniu ochronnym IPX5 lub przewodu zasilającego 3x2,5mm².

(C) Rekomendowane położenie osi baterii naściennej.

 Podgrzewacz wody

 Pompa wodna

 Dmuchawa

 Sterownik W400

 Sterownik MX600

EL Panel kontrolny

 Dysza wodna duża

 Ssak

 Halogen

 Korek zbiornika dezynfekcji

 Dysza wodna mała

 Dysza powietrzna

 Regulator powietrza tylko w W400