

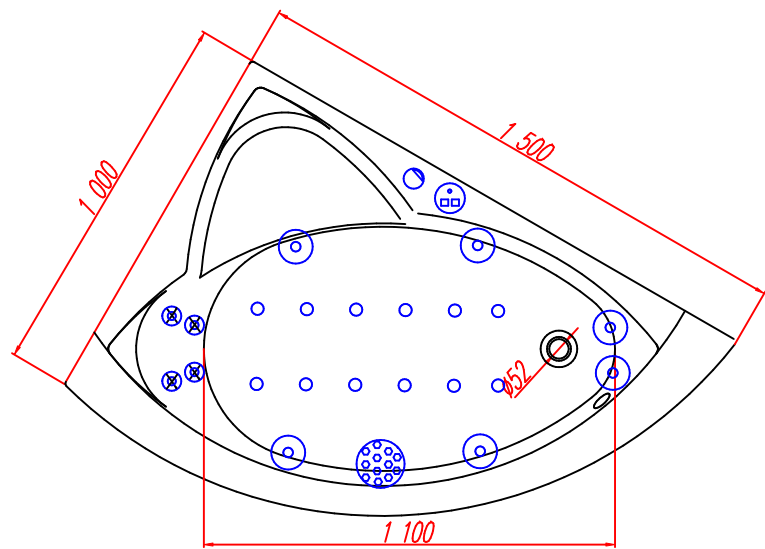

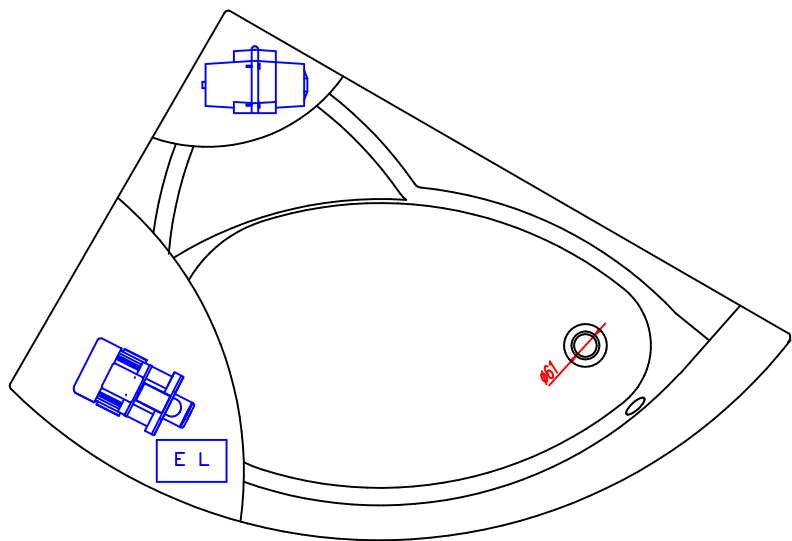

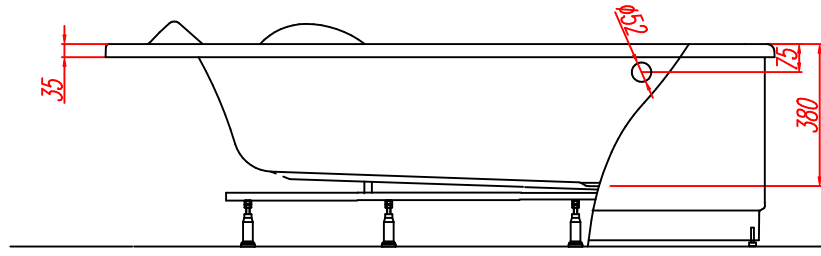

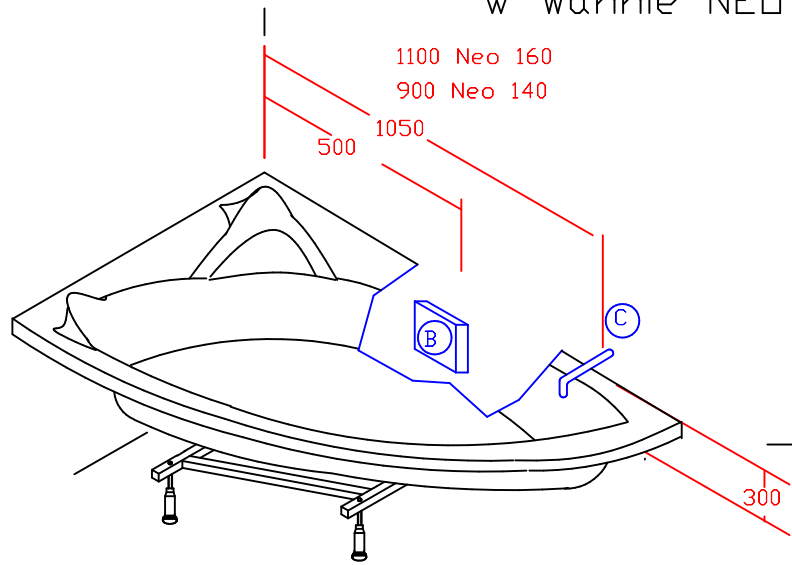
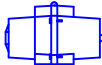

# Wanna NEO L 150x100 System W100, MX200

W wannie NEO L 140x100 i 160x100 takie same rozmieszczenie elementów



- (B)** Rekomendowane położenie instalacyjnej puszki elektrycznej o stopniu ochronnym IPX5 lub przewodu zasilającego 3x2.5mm<sup>2</sup>.
- (C)** Rekomendowane położenie osi baterii naściennej.
-  Dmuchawa
-  Pompa wodna
-  Sterownik W100
-  Sterownik MX200
- EL** Panel kontrolny
-  Dysza wodna duża
-  Ssak
-  Regulator powietrza
-  Mata dysza rotacyjna na plecy
-  Dysza powietrzna