

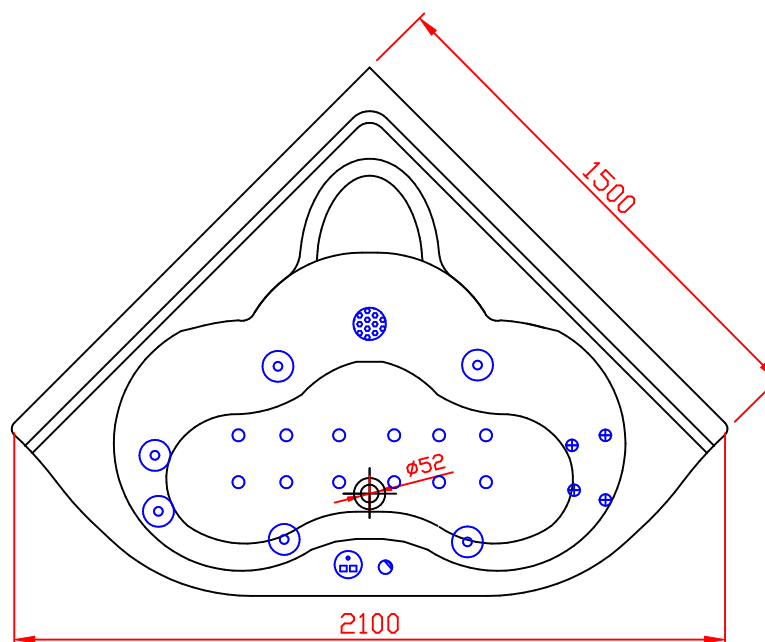

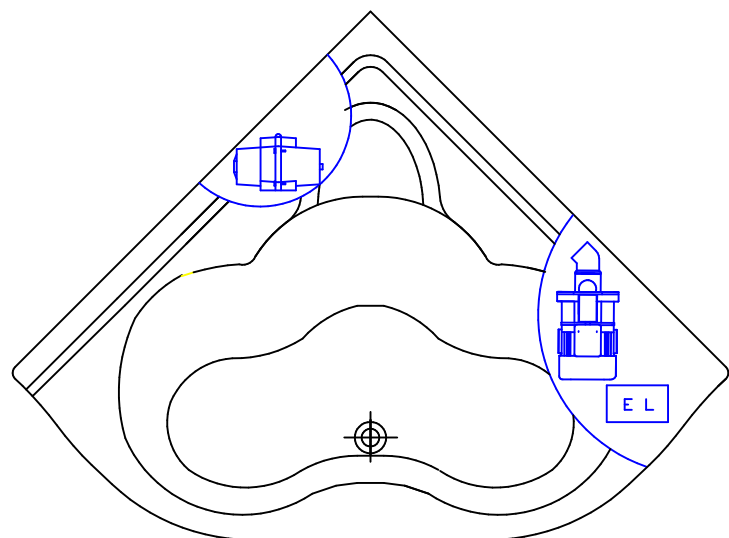

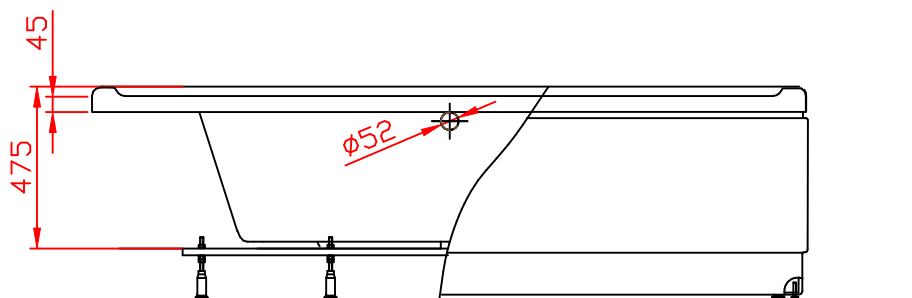

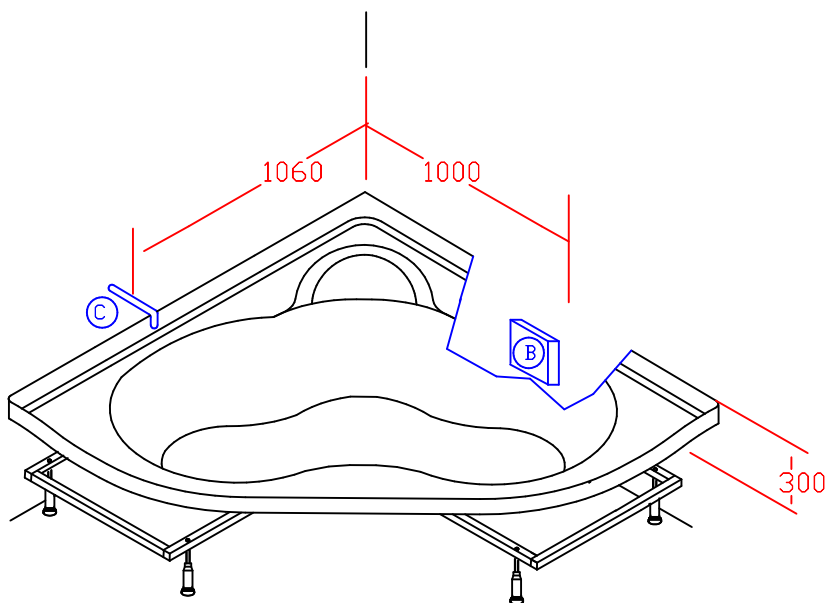



# Wanna CORNER OPTIMA system W100, MX200



- B** Rekomendowane położenie instalacyjnej puszki elektrycznej o stopniu ochronnym IPX5 lub przewodu zasilającego 3x2.5mm<sup>2</sup>.
- C** Rekomendowane położenie osi baterii naściennych.
-  Dmuchała
-  Pompa wodna
-  Sterownik W100
-  Sterownik MX200
- EL** Panel kontrolny
-  Dysza wodna duża
-  Ssaki
-  Regulator powietrza
-  Mała dysza rotacyjna na plecy
-  Dysza powietrzna