

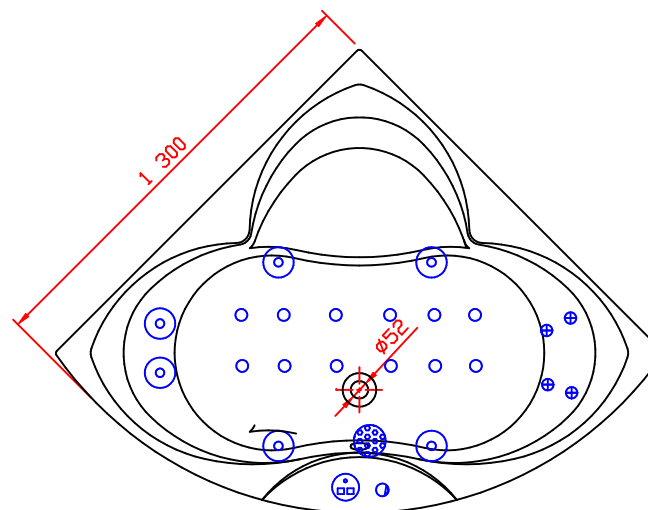

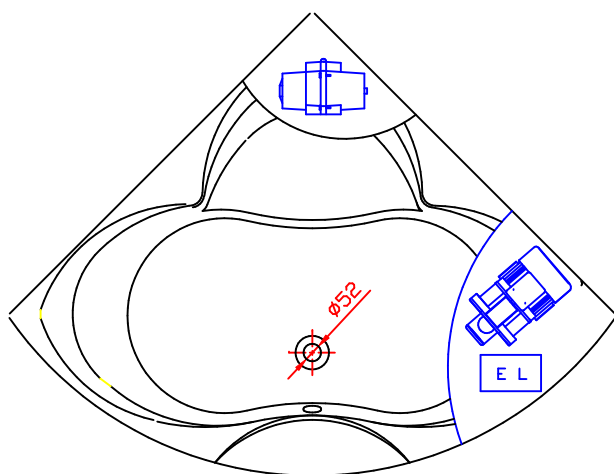

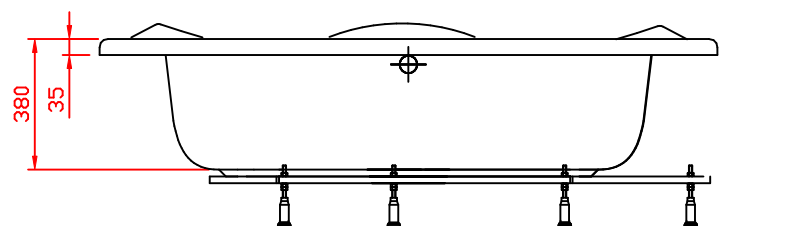

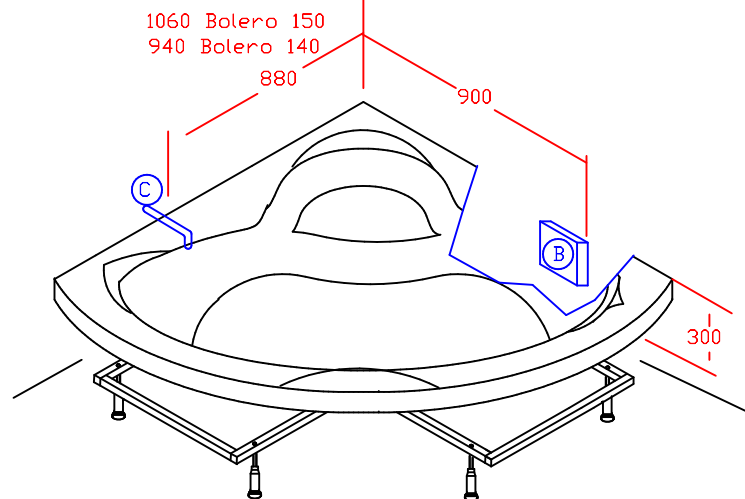



Wanna BOLERO 130 system W100, MX200

W wannach BOLERO 140 i 150 takie same rozmieszczenie elementów



-  Rekomendowane położenie instalacyjnej puszki elektrycznej o stopniu ochronnym IPX5 lub przewodu zasilającego 3x2,5mm².
-  Rekomendowane położenie osi baterii naściennej.
-  Dmuchawa
-  Pompa wodna
-  Sterownik W100
-  Sterownik MX200
-  Panel kontrolny
-  Dysza wodna duża
-  Ssak
-  Regulator powietrza
-  Mata dysza rotacyjna na plecy
-  Dysza powietrzna