

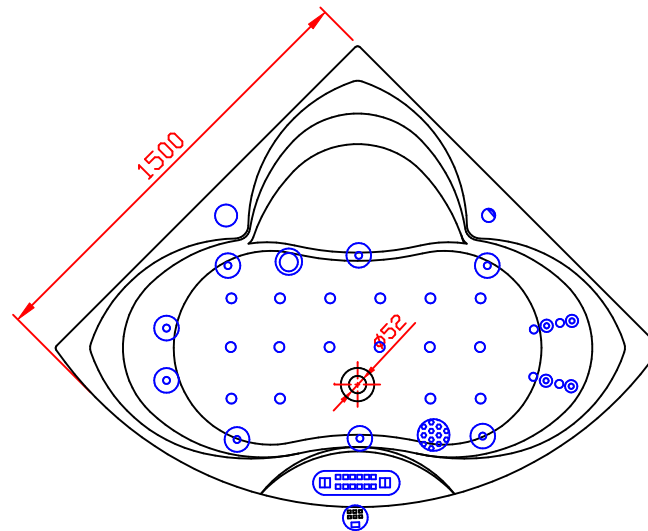

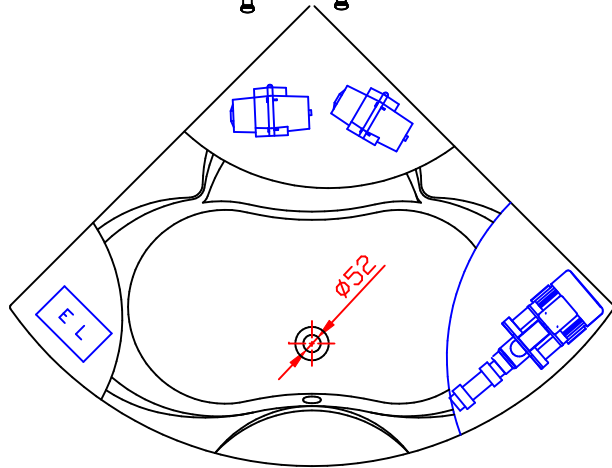

Wanna BOLERO 150- rozmieszczenie elementów w systemach W400,MX600,MX600PRO

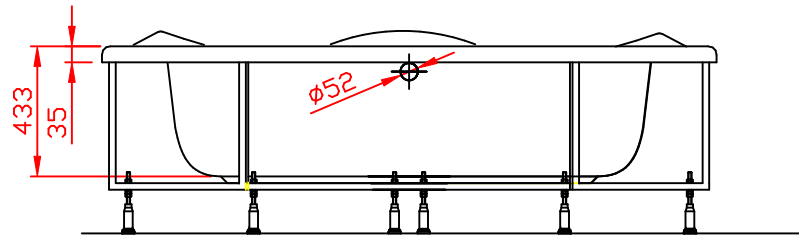
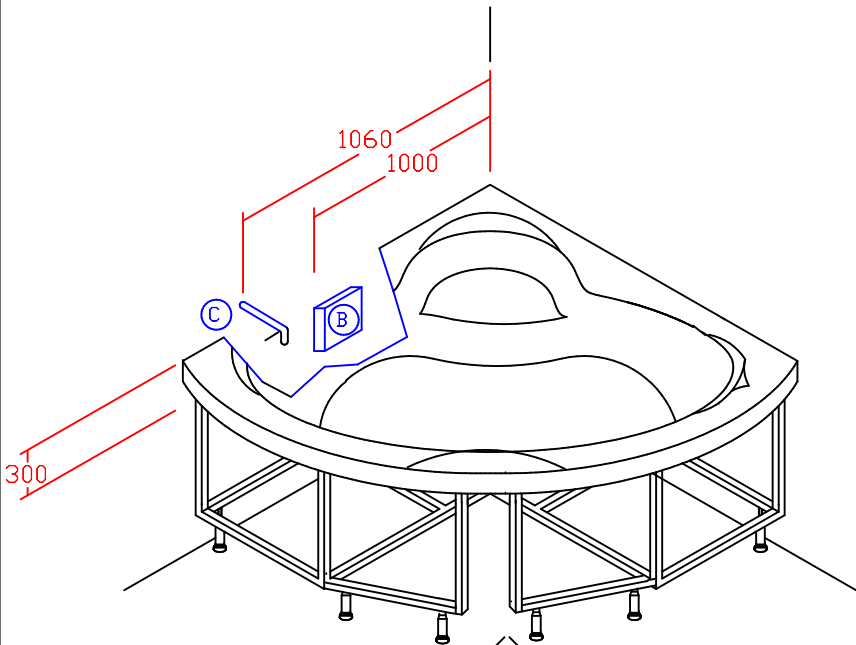

- B** Rekomendowane położenie instalacyjnej puszki elektrycznej o stopniu ochronnym IPX5 lub przewodu zasilającego 3x2.5mm².
- C** Rekomendowane położenie osi baterii naściennej.
-  Podgrzewacz wody
-  Pompa wodna
-  Dmuchawa
-  Sterownik W400
-  Sterownik MX600
- E L** Panel kontrolny
-  Dysza wodna duża
-  Ssak
-  Halogen
-  Korek zbiornika dezynfekcji
-  Dysza wodna mała
-  Dysza powietrzna
-  Regulator powietrza tylko w W400